

Ixxat INpact – Multi-protocol PCIe interfaces for industrial Ethernet and fieldbus communication

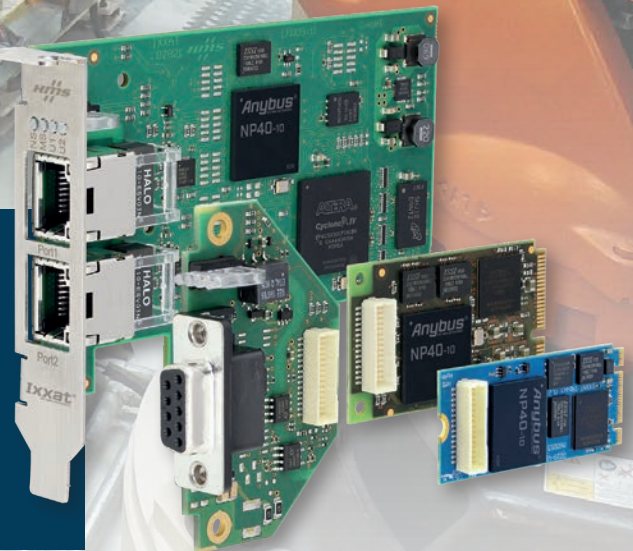



Highlights

- ✓ One board for all major industrial Ethernet networks and PROFIBUS
- ✓ Easy switching between protocols through a standardized API
- ✓ Easy integration thanks to different form factors
- ✓ High performance for demanding real-time applications
- ✓ Future-proof solution based on approved Ixxat and Anybus technologies

Ixxat INpact

Easy PC connectivity to any industrial network

Until now, it has been complicated to develop PC-based applications for several industrial Ethernet or fieldbus standards since different interface cards and application programming interfaces had to be used for each protocol.

Ixxat INpact simplifies the implementation and reduces your development costs significantly thanks to a protocol-independent solution that can be used in a wide range of applications.

Suitable for gateway, HMI and data acquisition applications, INpact allows you to connect your industrial PC or embedded system to many different industrial Ethernet and fieldbus networks. It combines proven Anybus technology with years of Ixxat know-how in the area of PC interface connectivity.

Future ready!

Benefit from our continuous product maintenance and new developments and implement new standards and future technologies on the fly.

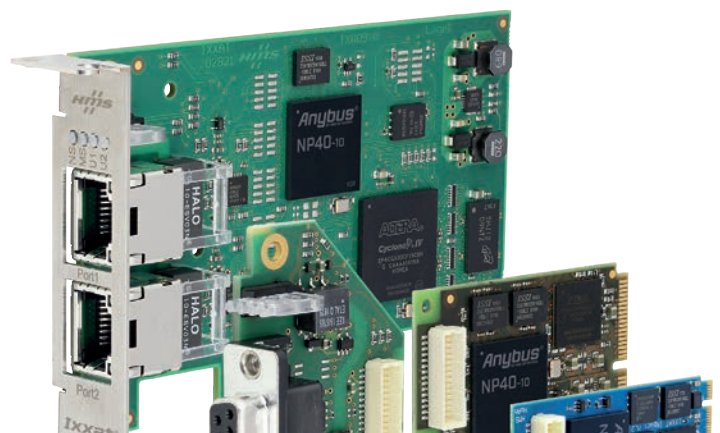

Ixxat INpact in M.2 format with the Anybus NP40 network processor

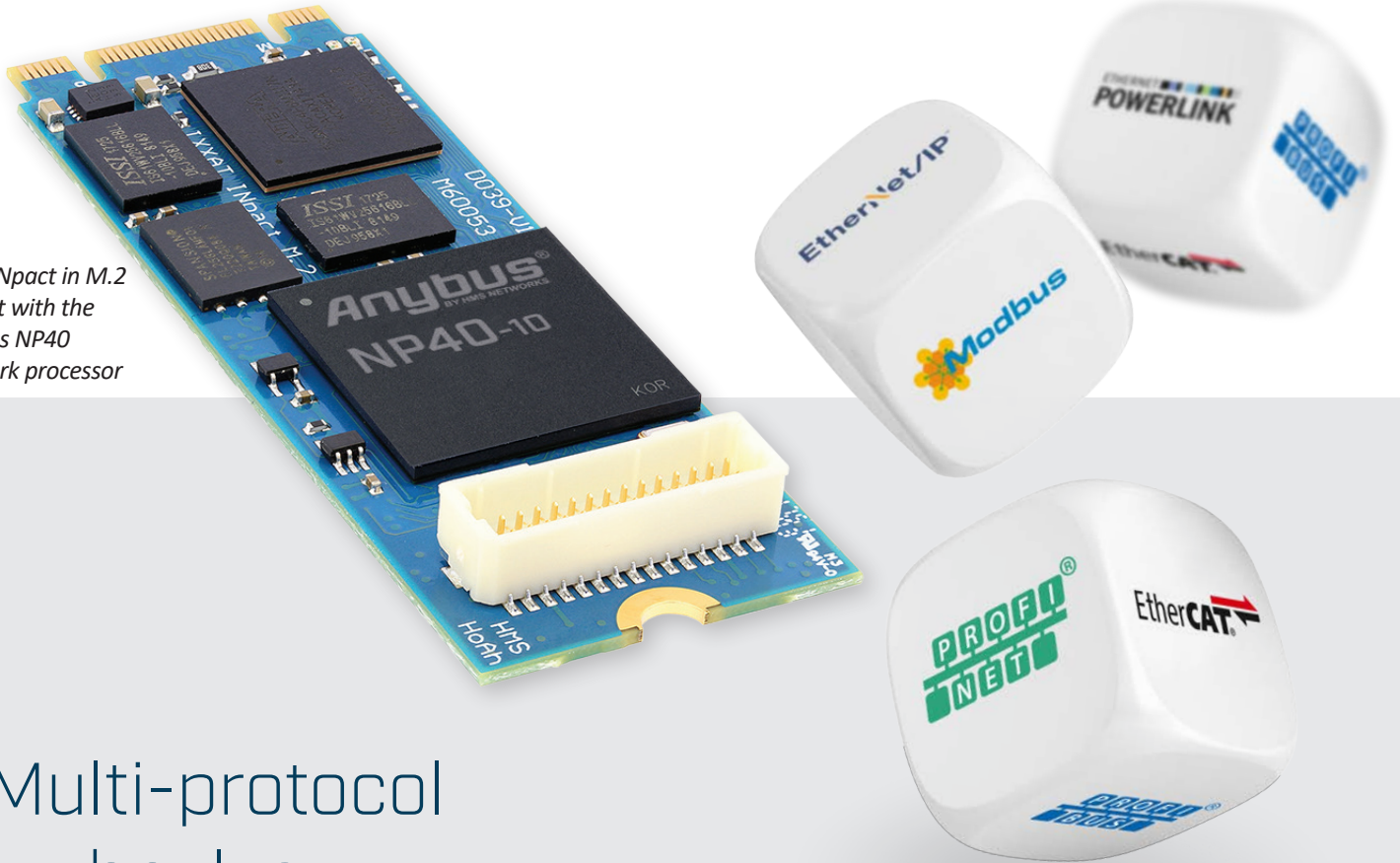

Multi-protocol technology







Ixxat INpact includes the Anybus CompactCom technology with the Anybus NP40 network processor – used within millions of industrial devices globally.

The FPGA-based Anybus NP40 network processor provides all functions required to handle the communication between the different Industrial Ethernet and fieldbus networks and the PC-based application.

The powerful multi-network approach of the NP40-based Ixxat INpact enables easy connection of PC-based or embedded slave applications to EtherNet/IP, EtherCAT, Powerlink, Modbus TCP, PROFINET IRT, PROFINET IRT Fiber Optic and PROFIBUS.

Anybus NP40 provides high performance for real-time applications, making Ixxat INpact the ideal choice for demanding industrial applications.

Supported protocols and formats

Protocol / Interface Format							
	EtherNet/IP	EtherCAT	Powerlink	Modbus	Profinet IRT	Profinet IRT Fiber Optic	Profibus
Interface name	INpact EIP Slave	INpact ECT Slave	INpact EPL Slave	INpact EIT Slave	INpact PIR Slave	INpact PIRFO Slave	INpact DPV1 Slave
PCIe (standard slot-brackets)	✓	✓	✓	✓	✓	✓	✓
PCIe (low-profile slot-brackets)	✓	✓	✓	✓	✓	✓	✓
PCIe Mini	✓	✓	✓	✓	✓	✓	✓
M.2	✓	✓	✓	✓	✓		✓

Implementation

– easy and flexible

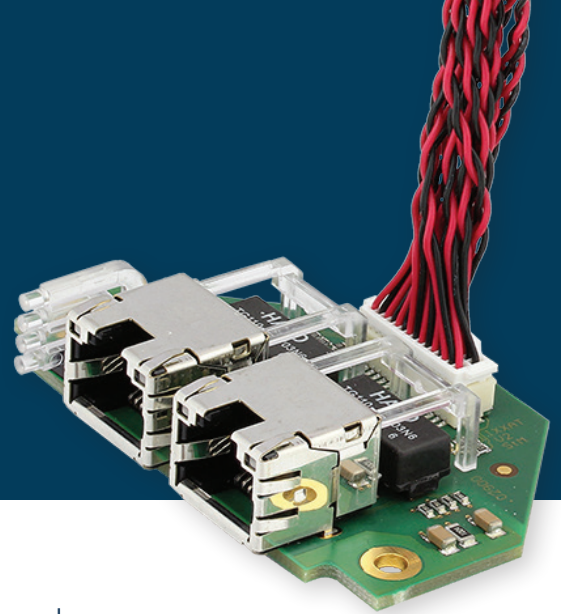

Develop independently of the used protocol

Ixxat INpact comes with a comprehensive driver package for Windows and Linux with a C programming interface, enabling easy and rapid development of customer-specific applications – independent of the used board version and protocol.

Thanks to the uniform application programming interface, it is possible to switch quickly between protocols without extensive programming, leading to increased flexibility and a reduction in terms of development costs.

Drivers for real time operating systems such as RTX, Intime, VxWorks and QNX are supported upon request.

Switch between the protocols on the fly

“Common Ethernet (CE)” and dedicated versions

The industrial Ethernet variants of the Ixxat INpact include two complementary approaches to industrial Ethernet connectivity:

- Dedicated versions for each Ethernet standard with pre-installed network protocols.
- The very flexible Common Ethernet solution which allows the desired industrial Ethernet protocol to be downloaded into a standardized Ethernet hardware. This enables easy and cost-efficient switching between all available industrial Ethernet protocols, minimizing the need for keeping stock of different product versions.

Uniform driver interface for all INpact cards

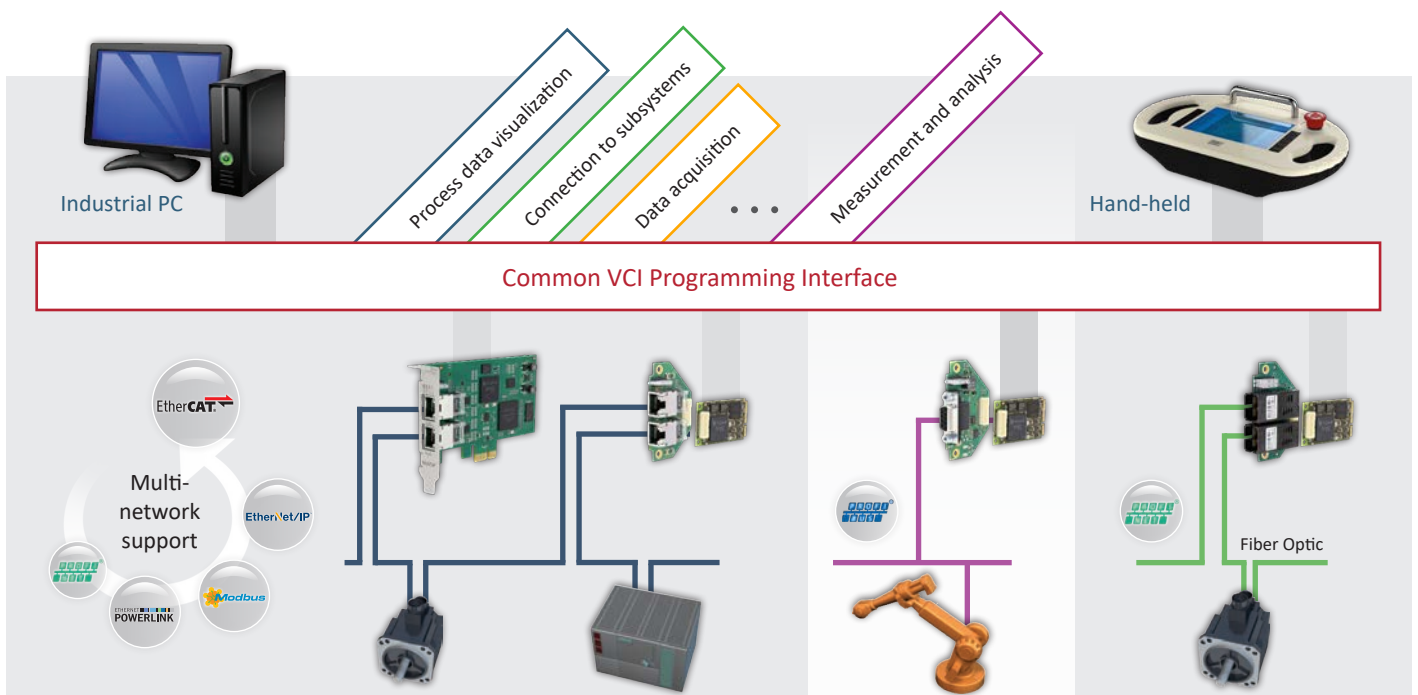



For industrial PCs and mobile devices

The INpact offering is available in three versions with different interfaces:

- PCIe, including standard or low-profile slot-brackets.
- PCIe Mini and M.2, for devices with limited available space and mobile devices

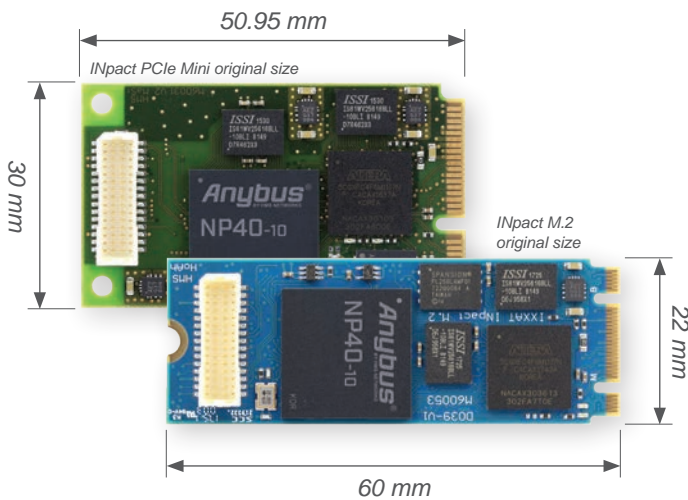

Designed to be used in many fields

- Connection of devices/subsystems as a slave to higher level networks
- Process data visualization e.g. within control stations or machines
- Data acquisition within test benches or test systems
- Highly flexible gateway

Customer Project



Panel PC meets Industrial Ethernet!

Ixxat INpact enables Industrial Ethernet access for AAEON's robust and stylish panel PC series.



The Ixxat INpact allows us to overcome one of the key challenges of the Industrial IoT: The connection of IT-level devices – where AAEON has its core competences – to the OT level, namely the different fieldbuses. The Ixxat INpact fits perfectly into our PC-systems, and provides the perfect combination of state-of-the-art technology and quality. By integrating the Ixxat INpact CE slave into our systems, we can offer our customers the best way to connect their application to the cloud and to multiple industrial networks.



Marco Barbato,
Director of PSM & Technical Department,
AAEON, an ASUS assoc. co.

Ixxat Mini Bracket

Same as for the PCIe interfaces that are exchanged using the uniform slot plate, the PCIe mini and M.2 versions are exchanged in a simple way with the included Ixxat Mini Bracket. If no INpact Mini is mounted to the application, the housing can be sealed using the pre-made "INpact Ready" plate.

Adaptable

– to your specific requirements

Flexible network connection

In addition to the INpact PCIe versions with integrated bus interfaces, the PCIe Mini and M.2 variants are based on a modular concept consisting of the Ixxat INpact interface, a bus coupling unit and a cable for connecting the two components.

The connection to industrial Ethernet networks is achieved via the 2-port Ethernet interface (10/100 Mbit, RJ45), which also supports

protocol specific switch functions – such as IRT for PROFINET, DLR for EtherNet/IP and Hub for Powerlink. The PROFIBUS and PROFINET IRT FO (PCIe and PCIe Mini) versions are available with special bus coupling units featuring corresponding Sub-D9 and SC-RJ ports.

All network interfaces are galvanically isolated, which provides efficient protection against EMC issues and overvoltage.

Customized solutions

If you have specific requirements and need an OEM version or customized solution, HMS can offer a variety of different development services to meet your needs.

- Brand-labelling
- Hardware and software modification of standard products
- Completely custom designed products based on our core technologies

Technical data

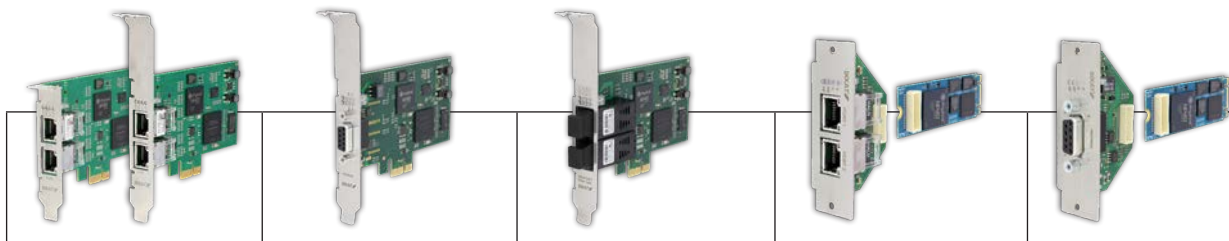

Format	PCIe Standard and Low Profile			M.2	
Supported protocols	EtherCAT, Powerlink, EtherNet/IP, Modbus-TCP, PROFINET IRT	PROFIBUS	PROFINET IRT Fiber Optic	EtherCAT, Powerlink, EtherNet/IP, Modbus-TCP, PROFINET IRT	PROFIBUS
Field bus interface	RJ45, two Ethernet ports, 100/10 Mbit	9-pin female Sub-D9	Two SC-RJ ports, 100 Mbit, full duplex	RJ45, two Ethernet ports, 100/10 Mbit	9-pin female Sub-D9
PC interfaces	PCI Express single lane port (x1) acc. to PCI Express base spec, rev. 1.1			PCI Express single lane port (x1) acc. to PCI Express base spec, rev. 1.1	
Network handling	Anybus NP40			Anybus NP40	
Power supply	Via PCIe (3.3 V / 12 V DC)			Via PCIe (3.3 V)	
Current consumption	Typ. 270 mA / 3.3 V DC, 120 mA / 12 V DC	Typ. 100 mA / 3.3 V DC, 120 mA / 12 V DC	Typ. 600 mA / 3.3 V DC, 120 mA / 12 V DC	Typ. 600 mA / 3.3 V DC	
Form factor	Standard height / low profile PCI Express add-in card profile			M.2 2260 (Key B-M)	
Operating temp.	0 °C to 70 °C (optional: -40 °C to 70 °C)		0 °C to 60 °C	-20 °C to 60 °C	
Galvanic isolation	1,500 Vrms			1,500 Vrms	
Dimensions	64 x 105 mm			22 x 60 x 12 mm (only M.2 interface with cable)	

Protocol-specific functions



ETHERNET POWERLINK

- Supports the Powerlink V2.0 profile, Version 1.2.0 (CN)
- Supports ring redundancy
- Up to 1490 bytes I/O data for each direction
- Up to 57343 ADIs
- Supports seg. SDO transfer
- Poll Response Chaining

Modbus

- Modbus-TCP Server/Slave
- Adaptable web server
- FTP server, email client
- JSON functionality
- Up to 1536 bytes I/O data for each direction
- Server Side Include
- Customizable identity information

EtherCAT

- CANopen over EtherCAT
- File Access over EtherCAT
- Modular Device Profil
- DS301 compliant
- Emergency support
- Up to 1486 bytes I/O data for each direction
- Distributed clock
- Customizable identity information

EtherNet/IP

- Beacon based DLR
- FTP server, email client
- Adaptable web server
- Server Side Include
- Up to 1448 bytes I/O data for each direction
- Up to 65535 ADIs
- Customizable identity inform.
- CIP Parameter Object support
- Extended CIP objects
- Unconnected CIP routing

- Conformance Class C
- Media Redundancy Protocol
- Generic and PROFINET specific diag. support
- Up to 1440 bytes I/O data for each direction incl. status bytes
- Up to 128 submodules in total
- Up to 32767 ADIs
- FTP server, email client
- Server Side Include
- JSON functionality

- Profibus DP-V1 & DP-V0
- Automatic baud-rate detection
- Generic and PROFIBUS specific diagnostic support
- User Parameterization Data
- Set Slave Address
- ADI access via DP-V1 read/write services
- Up to 488 bytes of IO data (244 bytes in each direction)
- Device identity customization

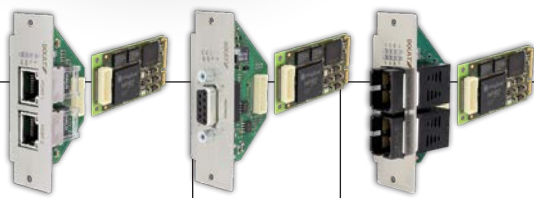

PCIe Mini

EtherCAT, Powerlink, EtherNet/IP, Modbus-TCP, PROFINET IRT	PROFIBUS	PROFINET IRT Fiber Optic
RJ45, two Ethernet ports, 100/10 Mbit	9-pin female Sub-D9	Two SC-RJ ports, 100 Mbit, full dupl.
PCI Express single lane port (x1) acc. to PCI Express base spec, rev. 1.1		
Anybus NP40		
Via PCIe (3.3 V)		
Typ. 600 mA / 3.3 V DC	Typ. 600 mA / 3.3 V DC	Typ. 800 mA / 3.3 V DC
Full Mini Card Format		
-40 °C to 60 °C		-25 °C to 60 °C
1,500 Vrms		
30 x 50.95 x 12 mm (only PCIe Mini interface with cable)		



Work with HMS.
The number one choice for
industrial communication
and IIoT.



Twincomm
de Olieslager 44
5506 EV Veldhoven
the Netherlands

T +31-40-2301.922
F +31-40-2301.923
E welcome@twincomm.nl

Embedded Networking Solutions

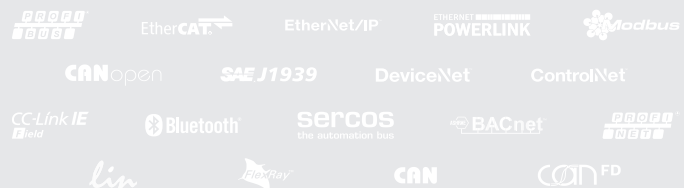

Discover our complete program at www.twincomm.nl

Ixxat® is a registered trademark of HMS Technology Center Ravensburg GmbH. Other marks and words belong to their respective companies. All other product or service names mentioned in this document are trademarks of their respective companies.

Part No: MMI114-EN Version 6 03/2019 - © HMS Industrial Networks - All rights reserved - HMS reserves the right to make modifications without prior notice.